

Article number: 0106077

Description: Retaining ring JV 62

Measures

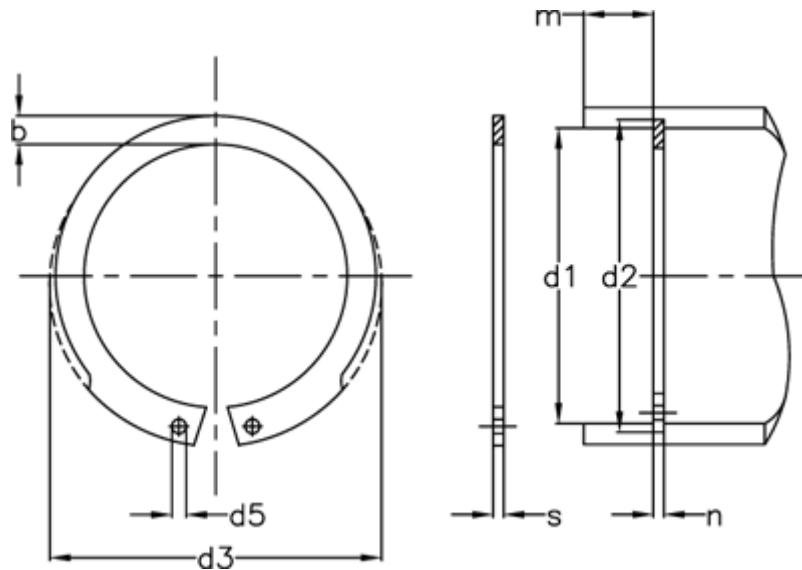

AN mm ²	= 150	FRg kN	= 12.3	tol	= 0.2
b	= 5.2	FR kN	= 60.0	tol	= -0.07
d1	= 62	g	= 2.0	tol	= +1,10-0,46
d2	= 65.0	K kN-mm	= 107.0	tol	= +0,30
d3	= 66.2	m min	= 2.15	Tong	= ZGJ-3
d5 min	= 2.5	Nominal drive	= 4.5	Weight kg/1000	= 11.75
Description	= JV 62	s	= 2.00		
FN kN	= 25.00	t	= 1.50		